

**SMART EARTHING  
MONITORING SYSTEM**



# Smart Power Grid Monitoring Through Earthing System



**Aplicaciones Tecnológicas S.A.** is a Spanish technological company with a strong international presence. Founded in 1986 with a multidisciplinary human team, extensive experience in different sectors and formed by experts in engineering, physics, electronics, communications, IT, IoT, data science and new technologies





## SMART EARTHING

La gama tecnológica más completa de servicios y productos para el diseño, implementación y control de tomas de tierra.

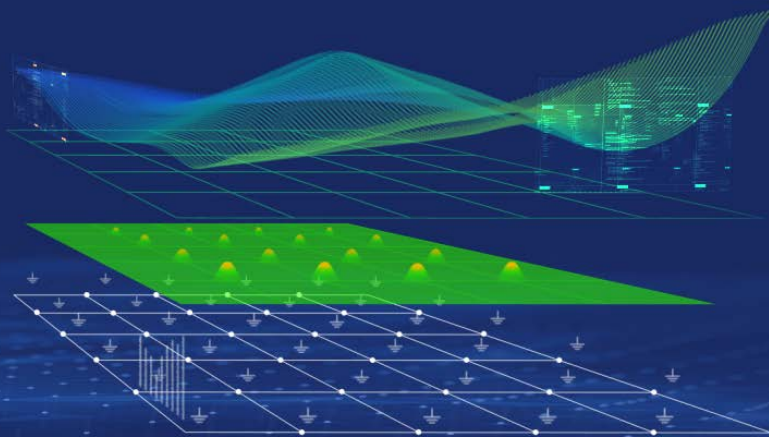

## SMART LIGHTNING

La gama tecnológica más completa de servicios y productos para la seguridad frente a tormentas eléctricas, incorporamos la conectividad y otras soluciones inteligentes que crean valor, permitiendo el control de activos públicos y privados a través de una plataforma IoT.



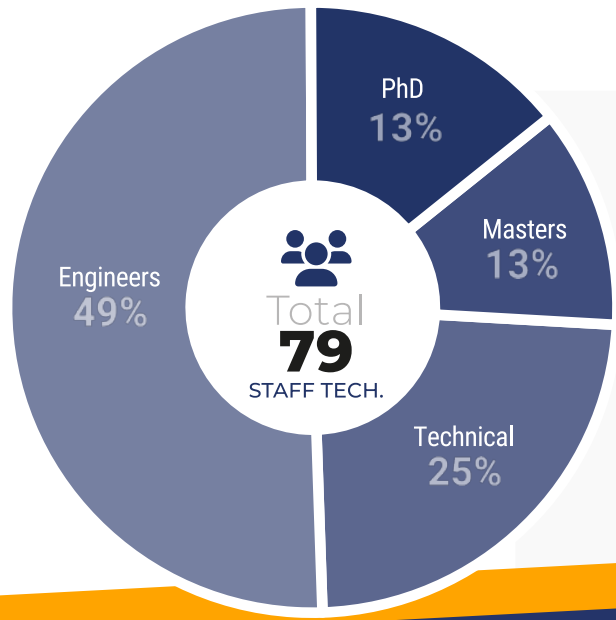

### Technical Profiles & Areas

- Architecture
- Data Science
- Physics
- Civil Engineering
- Industrial Engineering
- Computer Engineering
- Telecommunications Engineering
- Mechanical Engineering
- Chemistry
- Mathematics
- Automation Engineering



# INTERNATIONAL REFERENCES

▶ Wanda Metropolitano Stadium



▶ Zhuhai - Macao Bridge



▶ Madrid - Barajas Airport



▶ Panteón Nacional Lisboa



▶ Beijing Olympic Tower

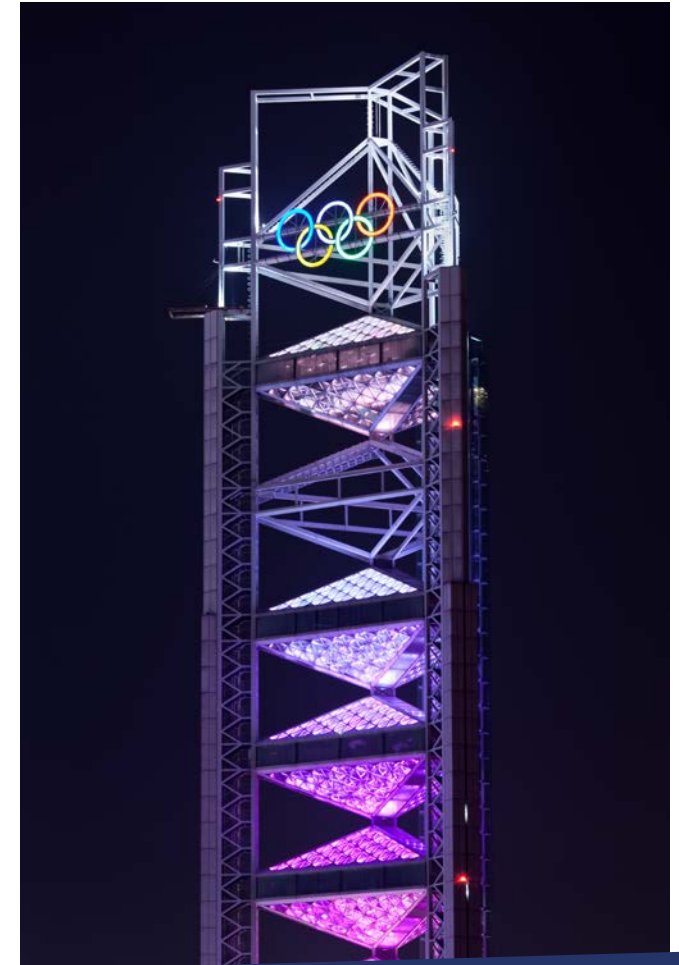

# INTERNATIONAL REFERENCES

▶ CITIC Building - Beijing



▶ CACSA - Valencia



▶ Garden by the Bay - Singapore



▶ TATA SKY - India



▶ East Bend Station - Ohio



## An Earthing System is the foundation of any electrical installation

- ▶ Any current excess will dissipate safely into earth, preventing personal injury and failure of the electrical components connected to it
- ▶ The safety of the people and equipment connected to it depends on its **design**, its **execution** and its **condition supervision**

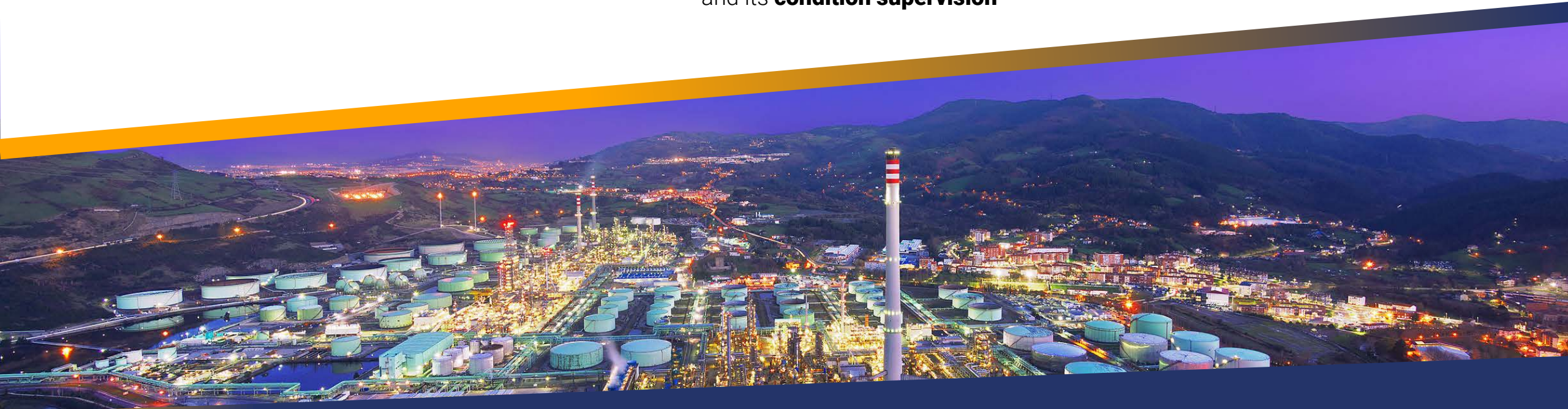



# SMART EARTHING MONITORING SYSTEM

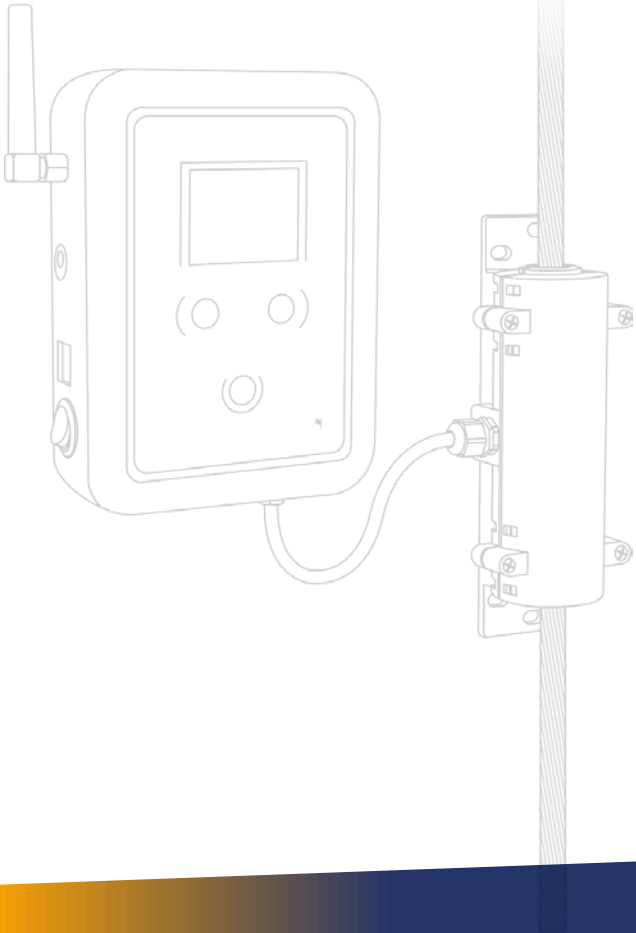

- ▶ Allows the **remote supervision** of the installed **earthing system**
- ▶ **Redefines** the **existing** passive **earthing systems** into **huge and active sensors** of electrical activity in the monitored facilities

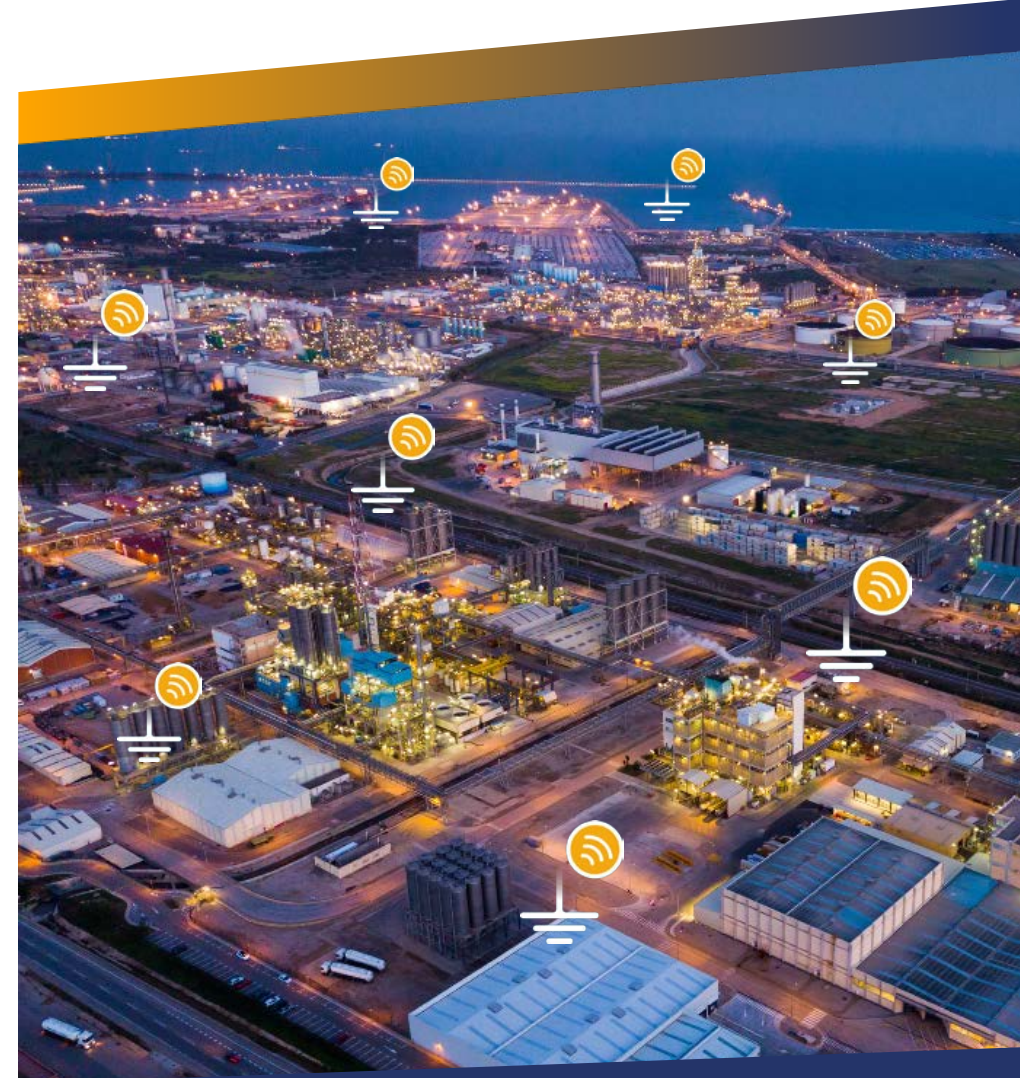

# 2 SYSTEM TYPICAL LAYOUT

## ELECTRICAL GENERATION

### Solar Farms

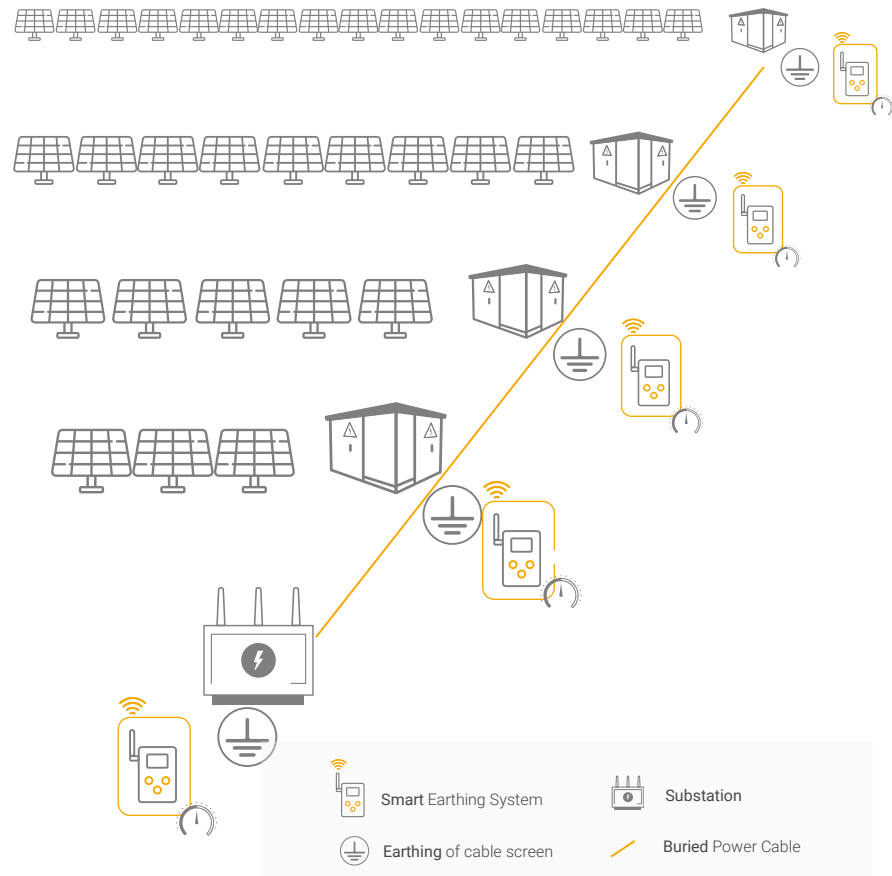

### Wind Farms

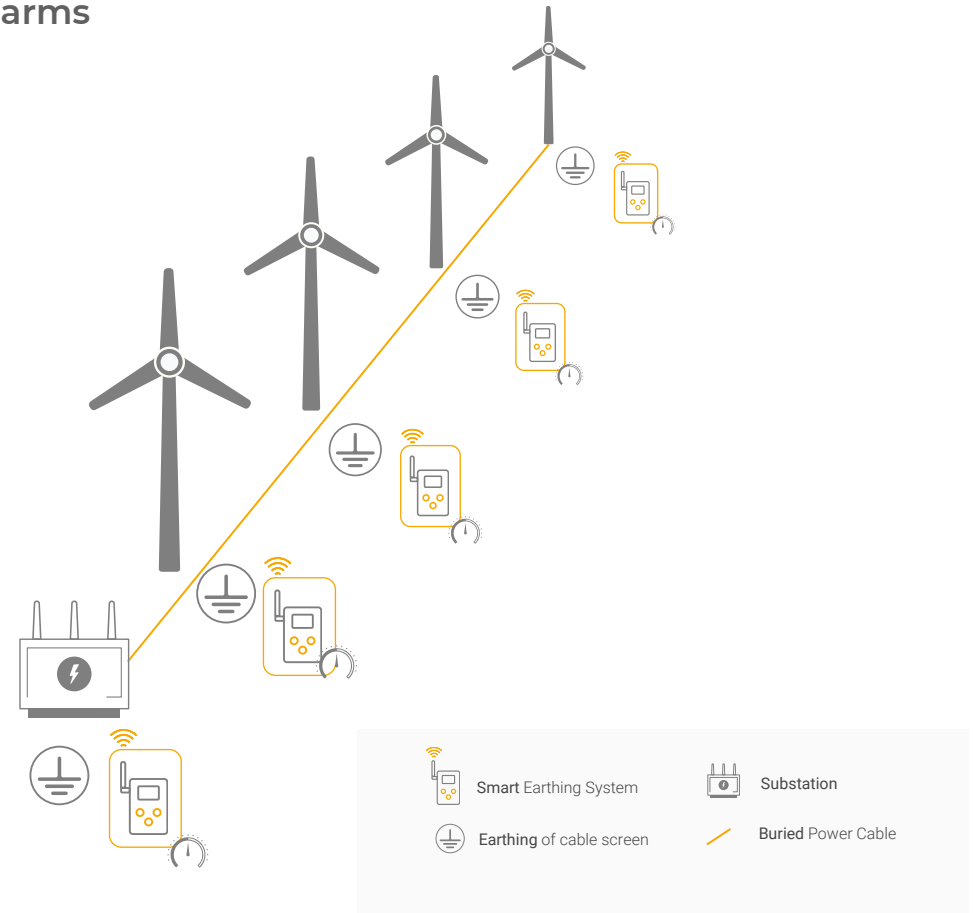

# 2 SYSTEM TYPICAL LAYOUT

## ELECTRICAL TRANSMISSION



Substations

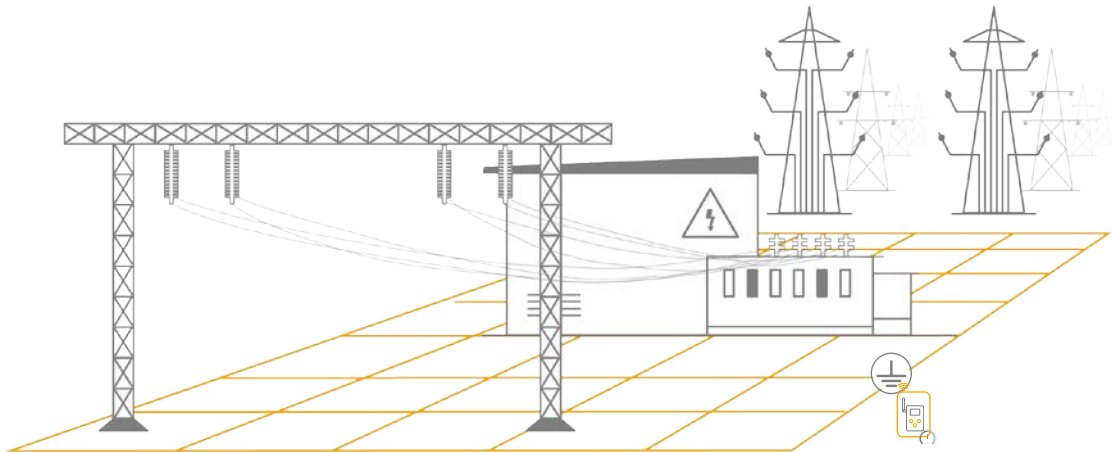

HV Towers

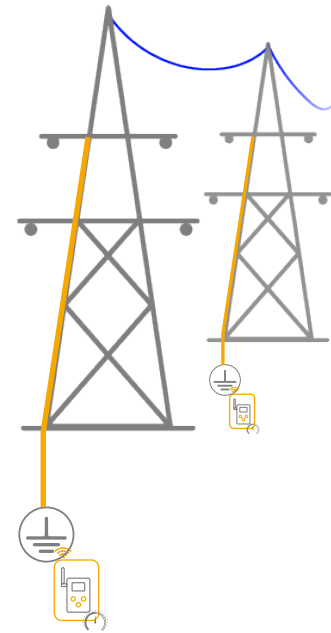

Overhead to Underground HV Towers

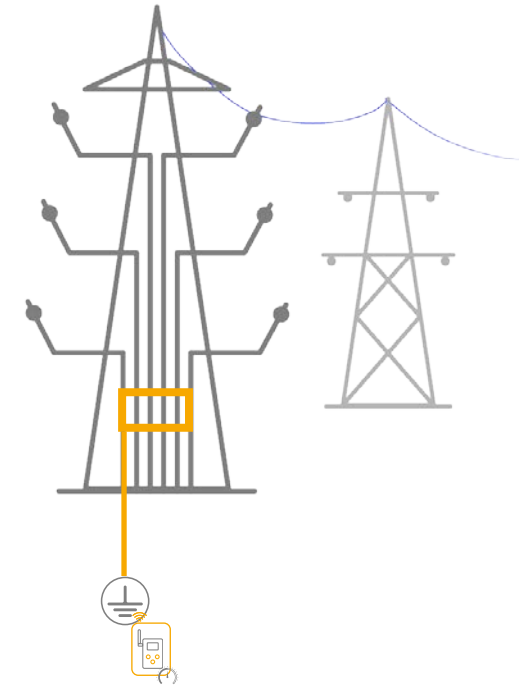

# 2 SYSTEM TYPICAL LAYOUT

## ELECTRICAL DISTRIBUTION



### Network of transformers

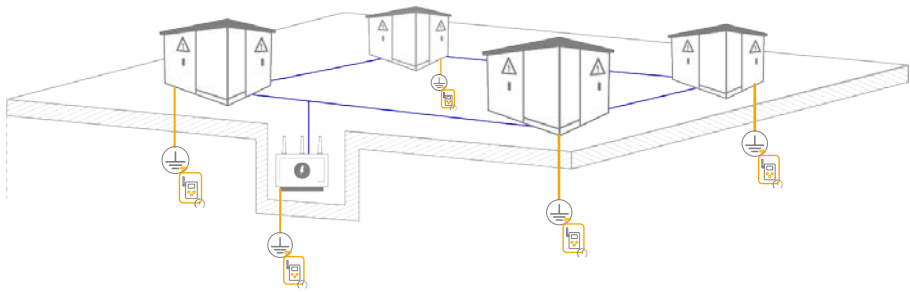

### On-pole transformers

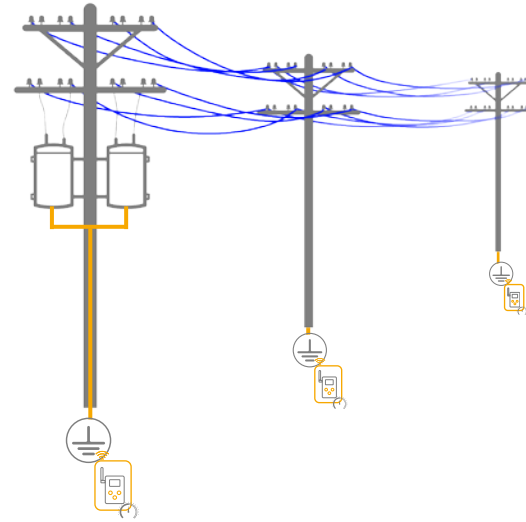

### Overhead to Underground MV Towers

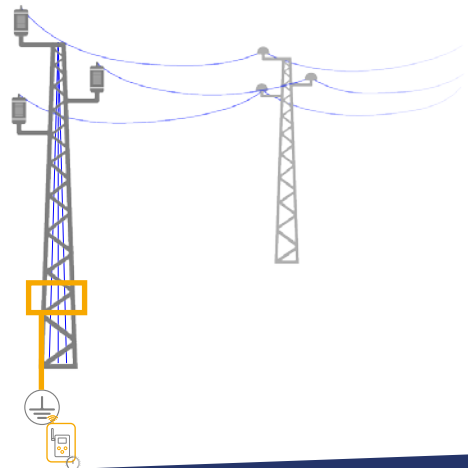

### MV Power Tower

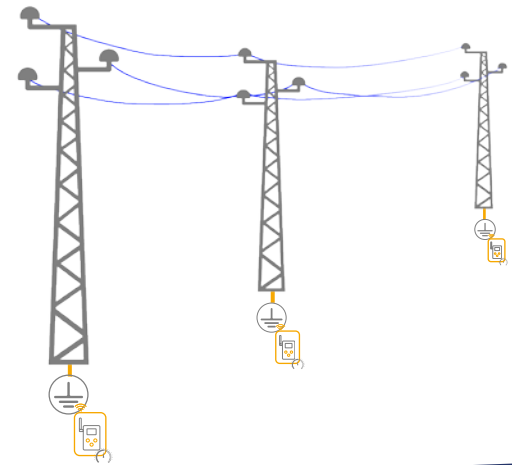

## Remote supervision of the installed earthing system

- ▶ **Real-time determination of earthing system values**
  - Logistical and operational optimization of regulatory checks
- ▶ **Verification of asset-to-earthing connections**
  - Identification of both, asset non-connection as well as unrequired connection to the earthing system
- ▶ **Evaluation of earthing continuity**
  - Real-time alerts related to conductors breakage, vandalism or theft
- ▶ **Monitoring of earthing system corrosion level**
  - Signal decomposition analysis allows for the identification of very slow trends associated with the oxidation phenomenon

## Earthing system as a huge and active sensor of electrical activity

- ▶ **Excessive leakage currents**
  - The detection of abnormal leakage current is normally linked to isolation degradation in the assets connected to the earthing system
- ▶ **Evaluation of current ground flow related with abnormal electrical activity in the facility**
  - Related to transformers, MV isolated cables, arresters, inverters, wind turbines, etc..
  - Presence of phase-neutral imbalances
  - Identification of the presence of harmonics' (50,100,150Hz...) in the earthing system to determine possible causes of failure
- ▶ **Evaluation of noise level present in the ground conductor**
  - Due to a defect in other elements connected to ground or by couplings on the monitored earthing systems.



# SMART EARTHING MONITORING SYSTEM



## FINANCIAL EFFICIENCY

**Cost savings** through logistical simplification of verification processes and early detection of asset failure situations



## RISK MINIMISATION

Prevention of **critical situations** -step and touch voltages, fatal asset damages, etc..-



## OPERATIONAL EFFICIENCY

**Data-driven predictive maintenance** that optimizes asset lifetime. **Real-time alerts for corrective maintenance.** Theft and vandalism detection.



# SMART EARTHING MONITORING SYSTEM

Loop impedance measurement method

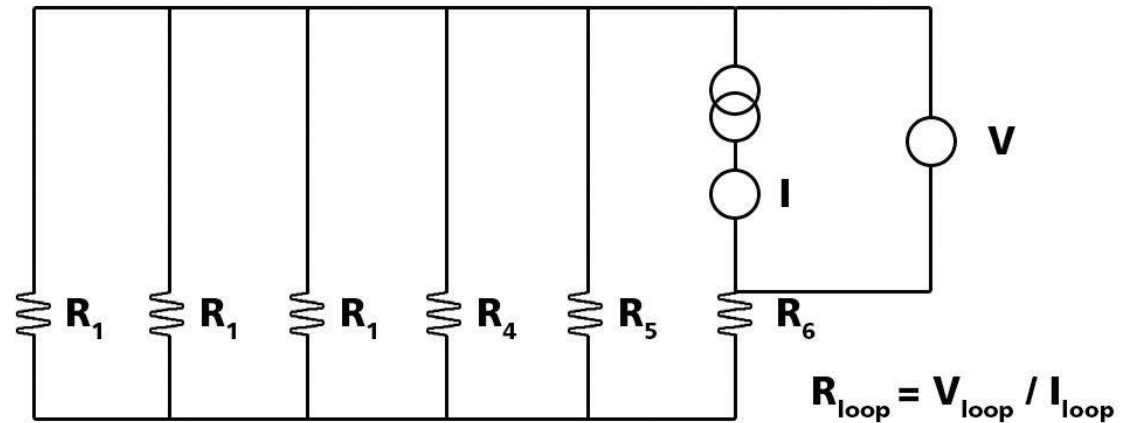
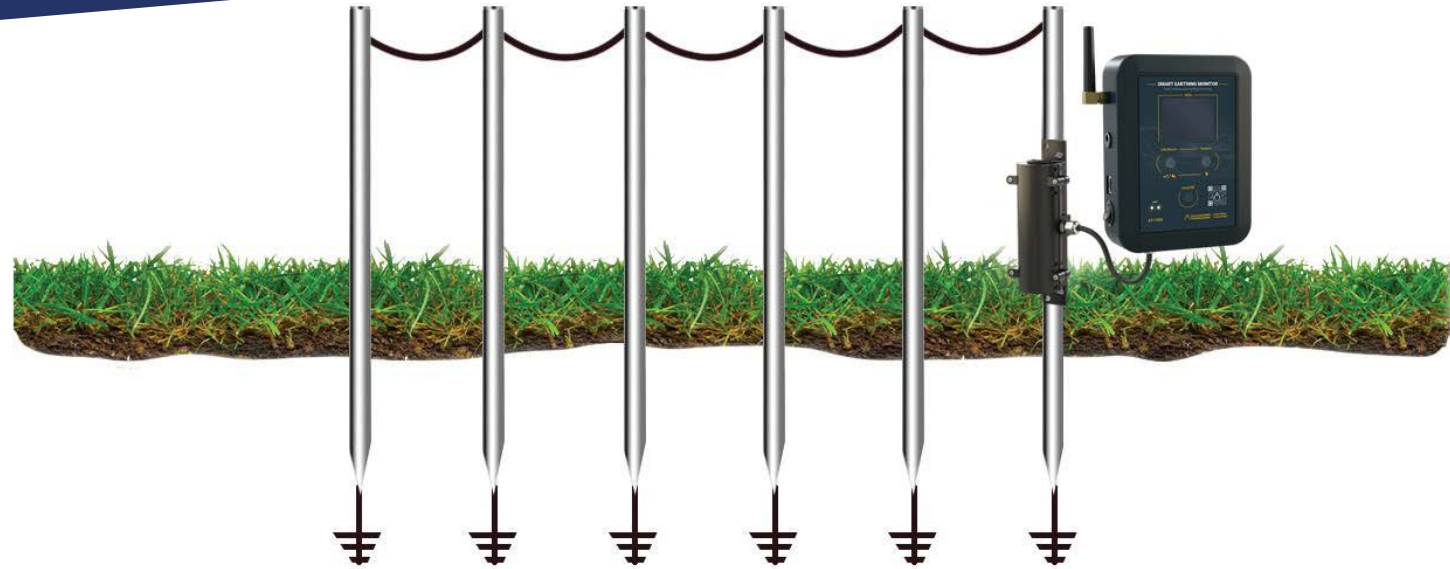

# 4 SYSTEM WORKING SQUEME

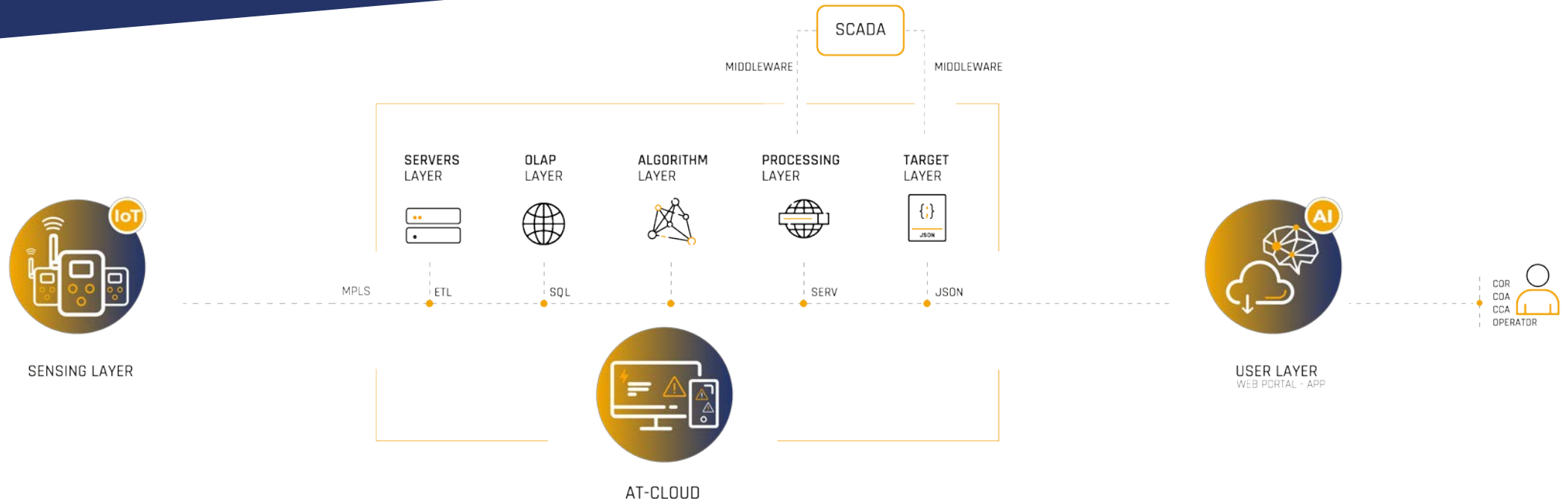

**Sensing layer** containing the distributed **smart sensors** on the assets to be monitored.

**Interpretation of data** through **AI algorithms** and server interaction transform **raw data into relevant information** for complete characterization of the monitored system.

**User info** can be delivered by **different configurable channels** and **access** to information segmented by user profile.

# 5 SYSTEM CONFIGURATION



## ► Power supply

- Mains power supply
- Direct from 48V batteries
- Autonomous supply via solar panel

## ► Battery

- 5Ah as power backup
- 10Ah for solar power applications

## ► Visualisation

- Optional 2.4" TFT screen for local operation

## ► Communication

- 2G/3G network
- IoT bands 4G (LTE-M, NB-IoT)
- LAN port Communication

## ► Enclosure

- Indoor use, wall or DIN rail mounting
- IP 65 outdoors weatherproof enclosure



## ► Gerçek zamanlı süreklilik

Süreklilik eksikliği tespit edildiğinde gerçek zamanlı uyarıların üretilmesi.

## Auto kalibrasyon

- Düzenleyici doğrulamalar için ekipmanın gözetimsiz kalibrasyonu.

## ► Genişletme bağlantı noktası

Sahadaki diğer cihazlarla iletişime izin verir

## ► Potansiyel -free çıkışlar

Lokal hareketler yapılandırılabilir

## ► Kaçak akım tespiti.

Topraklama sistemine bağlı ekipmandan gelen kaçak akımın tespiti ve değerlendirilmesi. (örn. Otomatik valfler, transformatörler vb.

## ► İletişim bağlantı noktaları

Harici sensörlerin iletişim merkezi olarak hizmet verecek analog ve dijital bağlantı noktaları

## ► Düğüm değerlendirme

Farklı topraklama sistemleri arasındaki ara bağlantının durum değerlendirilmesi

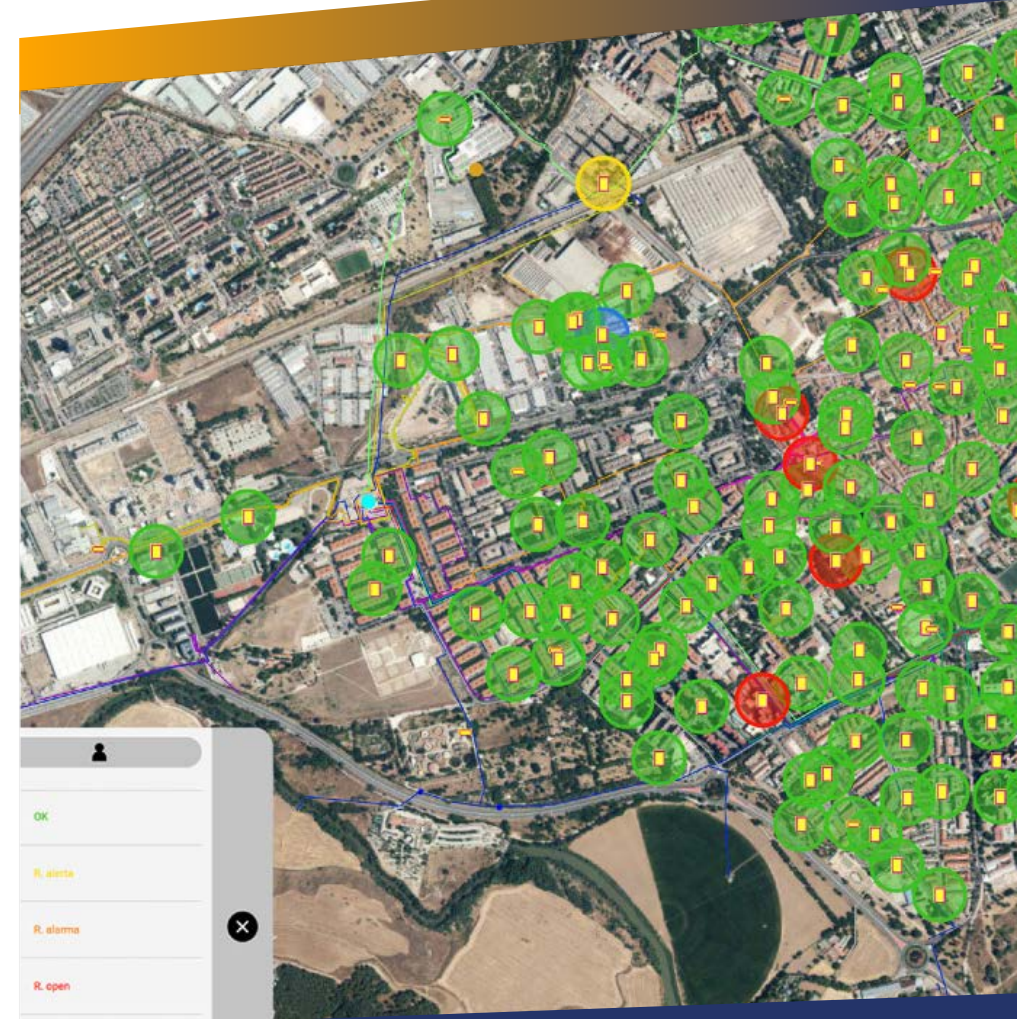

# 7 PLATFORM OPTIONS



## ▶ CCA platform

Alerts associated with earthing resistance, continuity measurements and leakage current

## ▶ COA platform

Alerts related to the equipment status.

## ▶ APP management for equipment activation/deactivation:

Mobile APP for management of activation/deactivation of installed equipment.

## ▶ SCADA

Integration of data processed in client's system.



## ▶ Application Maintenance Services

- Remote updating of the application
- 24x7 Technical Service
- Data backup

## ▶ Equipment Maintenance Services

- Remote equipment updates
- Remote equipment diagnostics
- 24x7 Technical Service
- Local data recovery
- Autocalibration

AT-CONNECT

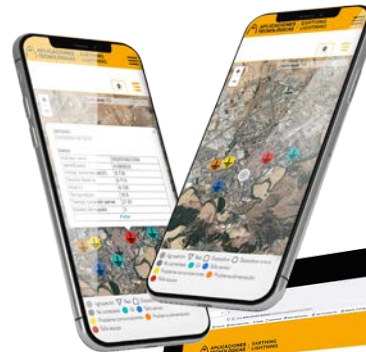

APLICACIONES TECNOLÓGICAS | EARTHING LIGHTNING



## Other recommended services and products

### Services

- ▶ Advanced geoelectrical studies.
- ▶ Earthing systems 4.0 projects.
- ▶ Smart storm detection projects.
- ▶ Lightning and overvoltage protection projects.

### Products

- ▶ **ATSTORM®**  
Smart early warning system for thunderstorm risk.
- ▶ **DAT CONTROLLER® REMOTE**  
Smart air terminals with IoT technology.
- ▶ **OVERVOLTAGES**  
Transient and permanent.



## **APLICACIONES TECNOLÓGICAS S.A.**

Parque Tecnológico de Valencia

 C/Nicolás Copérnico, 4 - 46980 Paterna (Valencia), ESPAÑA.

 (+34)961 318 250  atsa@at3w.com  at3w.com

