

**SMART EARTHING
MONITORING SYSTEM**



Smart Power Grid Monitoring Through Earthing System



Aplicaciones Tecnológicas S.A. is a Spanish technological company with a strong international presence. Founded in 1986 with a multidisciplinary human team, extensive experience in different sectors and formed by experts in engineering, physics, electronics, communications, IT, IoT, data science and new technologies





SMART EARTHING

La gama tecnológica más completa de servicios y productos para el diseño, implementación y control de tomas de tierra.

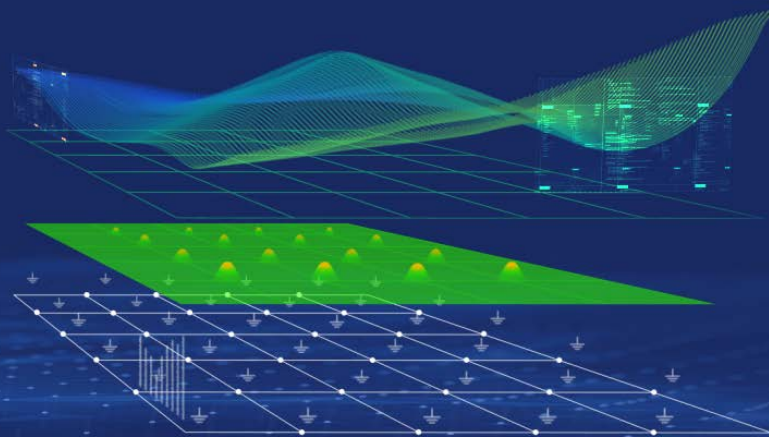

SMART LIGHTNING

La gama tecnológica más completa de servicios y productos para la seguridad frente a tormentas eléctricas, incorporamos la conectividad y otras soluciones inteligentes que crean valor, permitiendo el control de activos públicos y privados a través de una plataforma IoT.



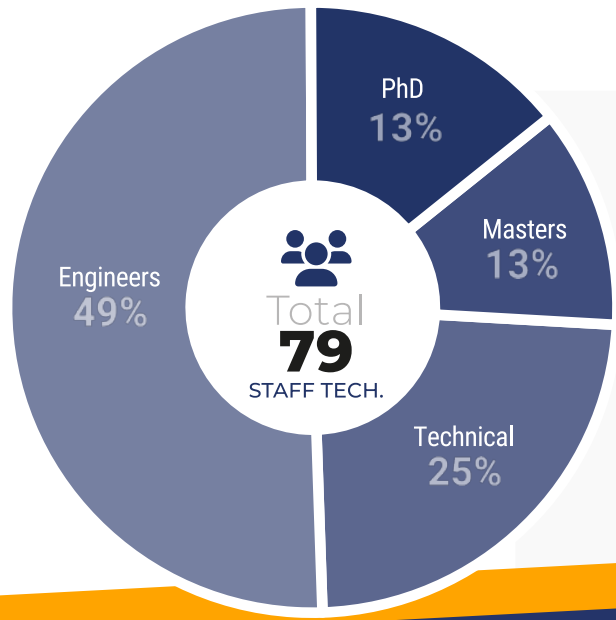

Technical Profiles & Areas

- Architecture
- Data Science
- Physics
- Civil Engineering
- Industrial Engineering
- Computer Engineering
- Telecommunications Engineering
- Mechanical Engineering
- Chemistry
- Mathematics
- Automation Engineering



INTERNATIONAL REFERENCES

▶ Wanda Metropolitano Stadium



▶ Zhuhai - Macao Bridge



▶ Madrid - Barajas Airport



▶ Panteón Nacional Lisboa

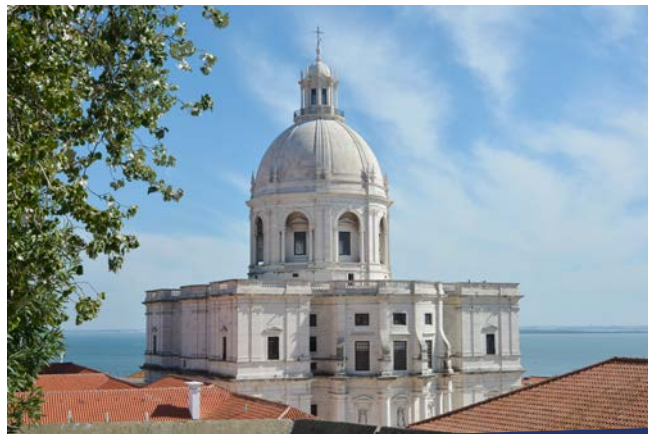

▶ Beijing Olympic Tower

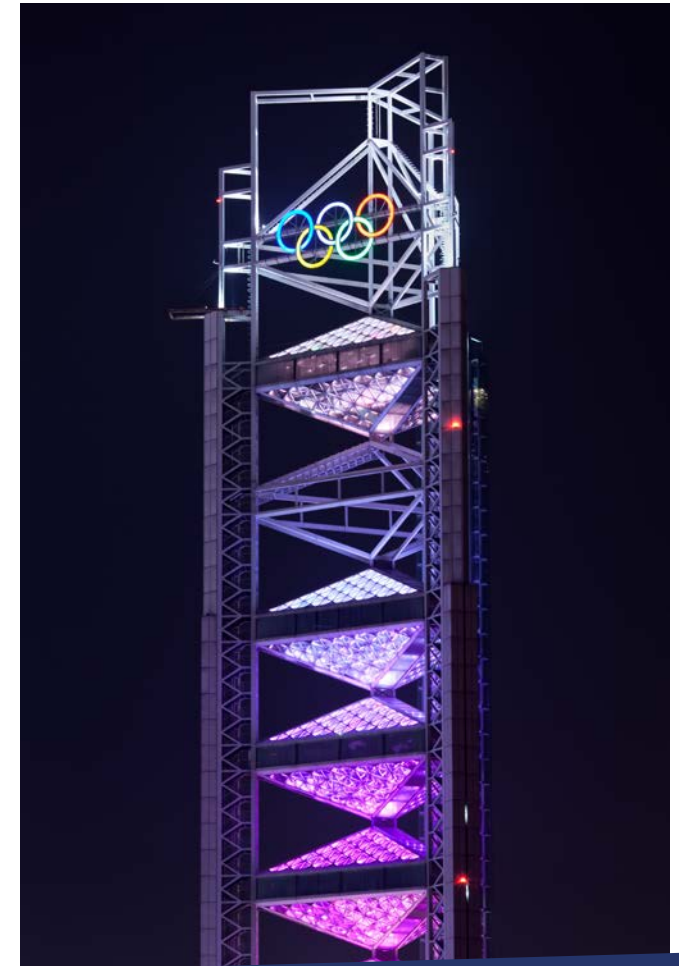

INTERNATIONAL REFERENCES

▶ CITIC Building - Beijing



▶ CACSA - Valencia



▶ Garden by the Bay - Singapore



▶ TATA SKY - India



▶ East Bend Station - Ohio



An Earthing System is the foundation of any electrical installation

- ▶ Any current excess will dissipate safely into earth, preventing personal injury and failure of the electrical components connected to it
- ▶ The safety of the people and equipment connected to it depends on its **design**, its **execution** and its **condition supervision**

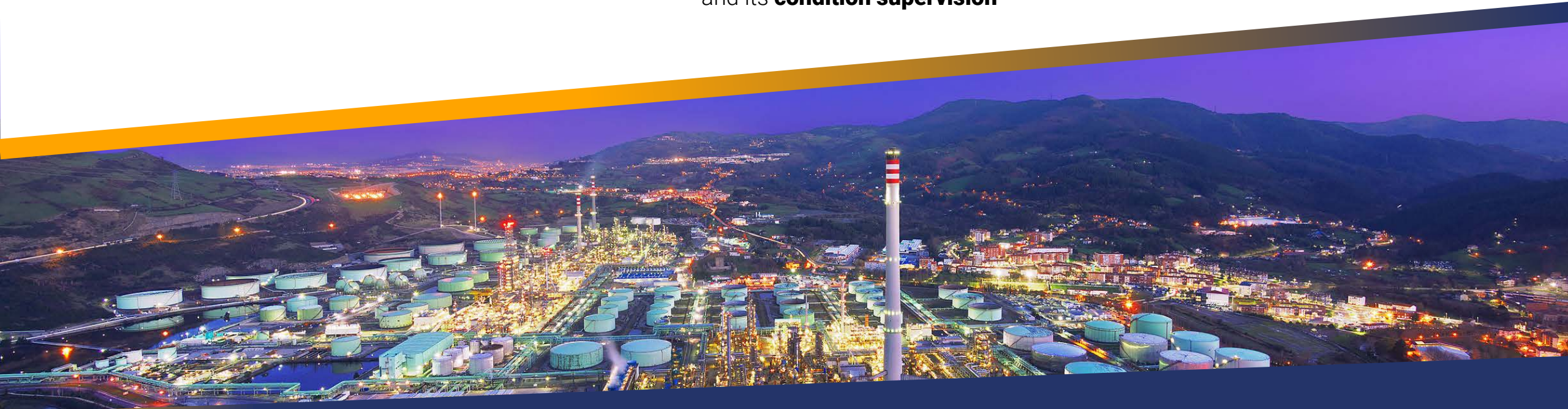



SMART EARTHING MONITORING SYSTEM

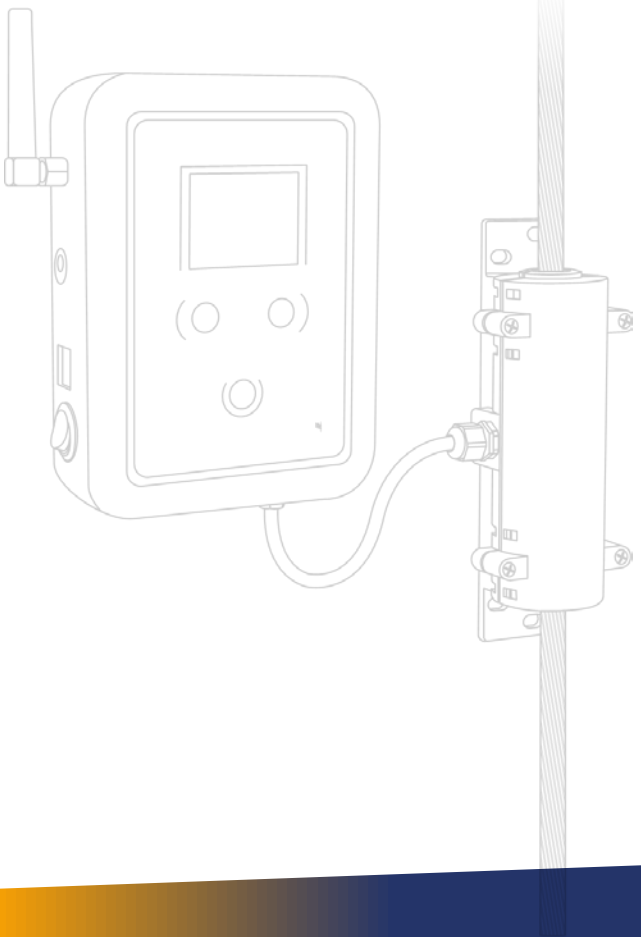

- ▶ Allows the **remote supervision** of the installed **earthing system**
- ▶ **Redefines** the **existing** passive **earthing systems** into **huge and active sensors** of electrical activity in the monitored facilities

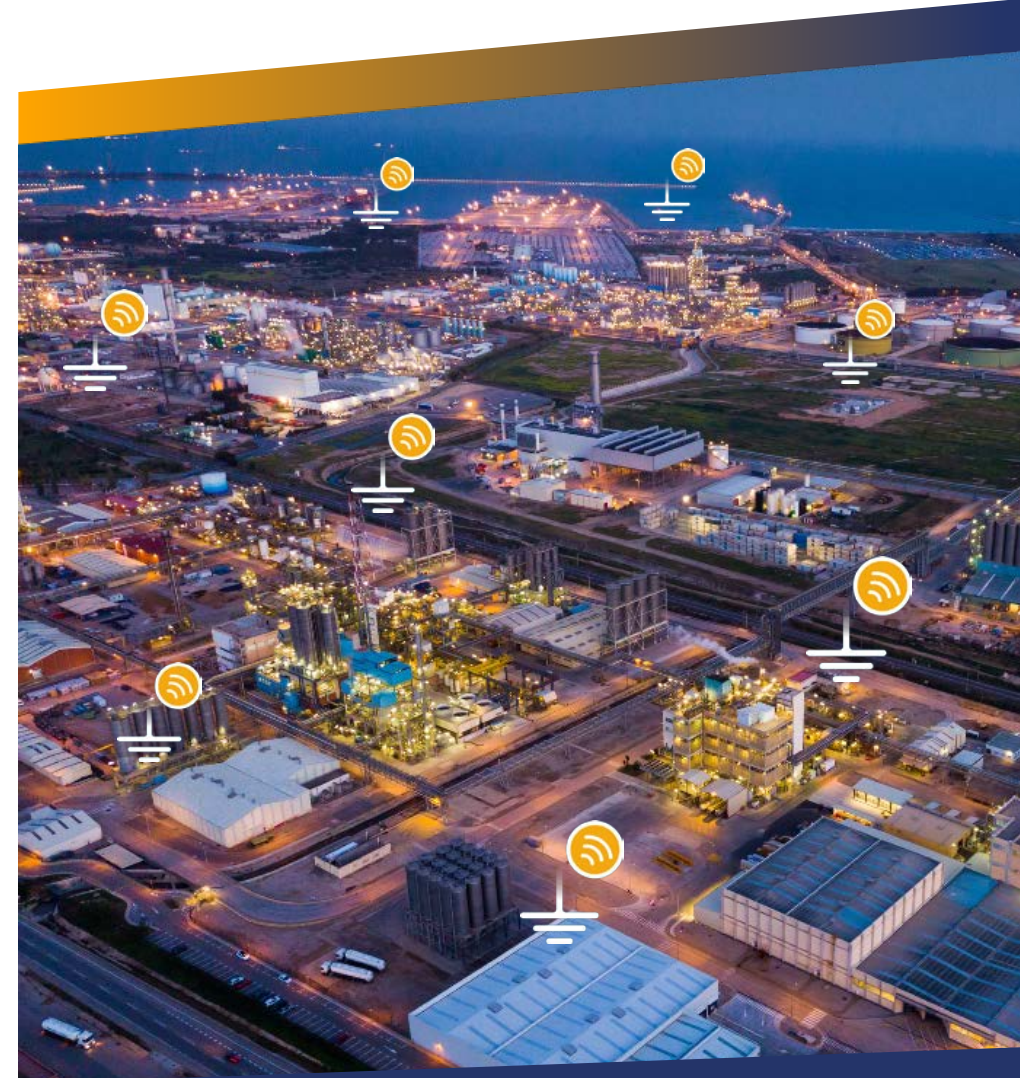

2 SYSTEM TYPICAL LAYOUT

ELECTRICAL GENERATION

Solar Farms

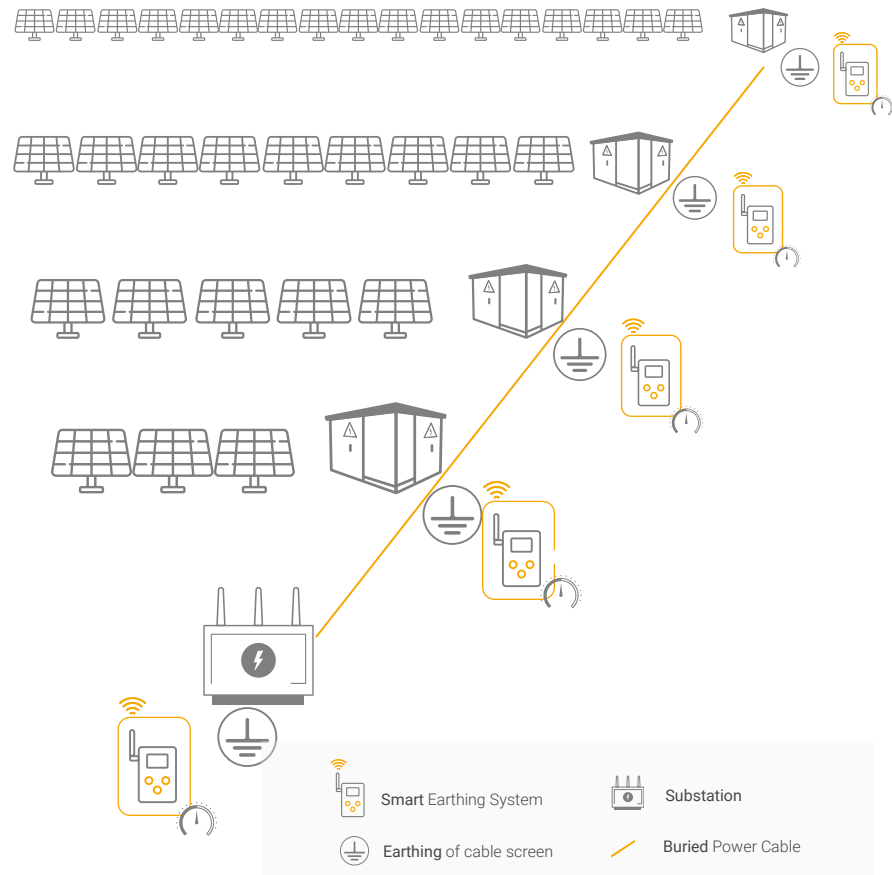

Wind Farms

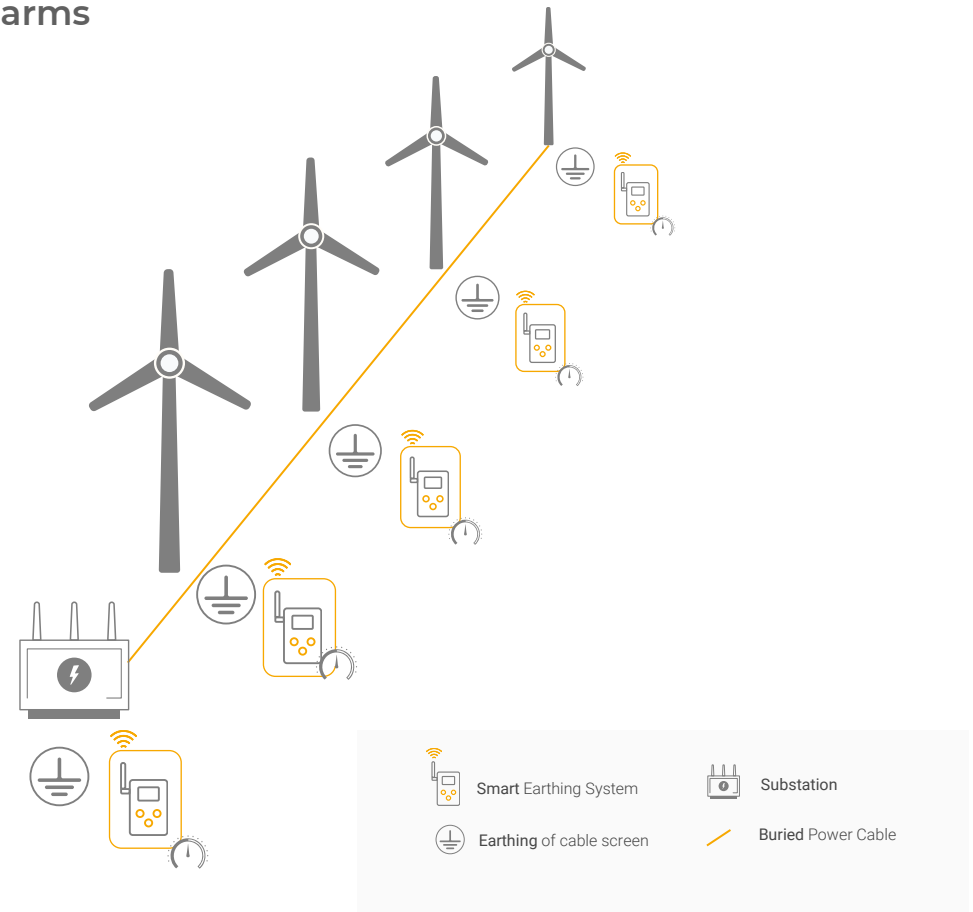

2 SYSTEM TYPICAL LAYOUT

ELECTRICAL TRANSMISSION



Substations

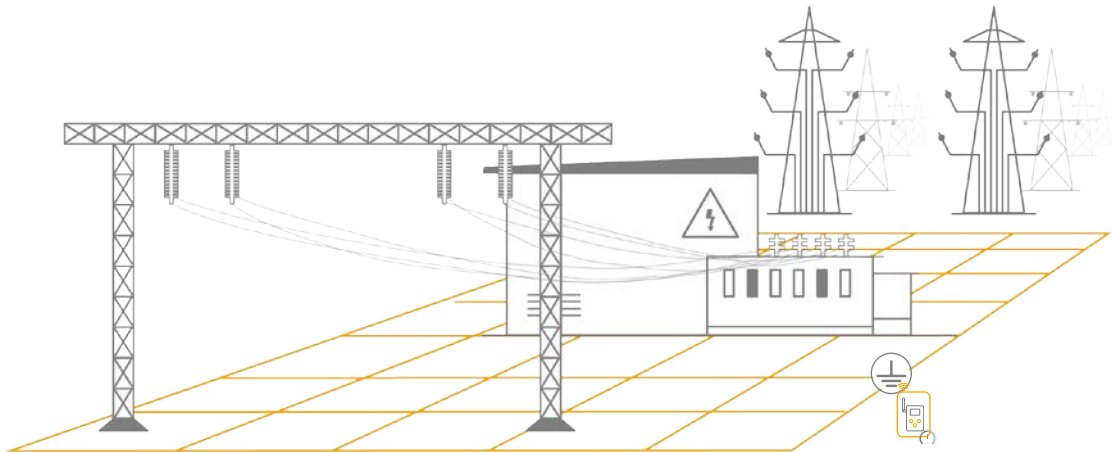

HV Towers

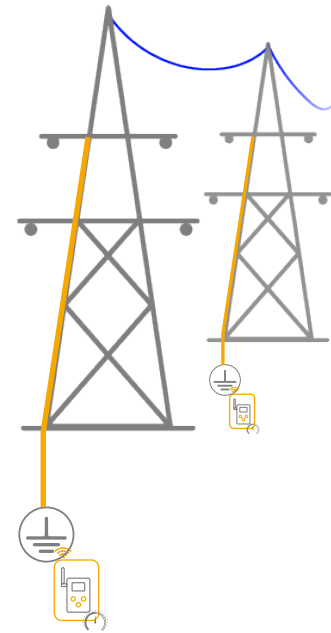

Overhead to Underground HV Towers

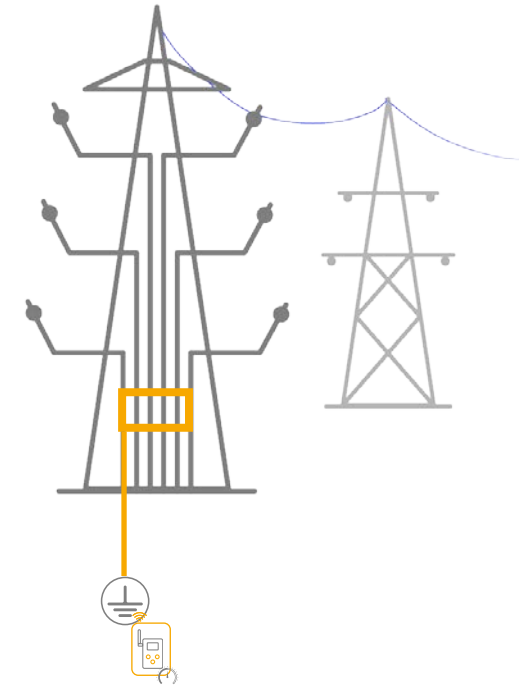

2 SYSTEM TYPICAL LAYOUT

ELECTRICAL DISTRIBUTION



Network of transformers

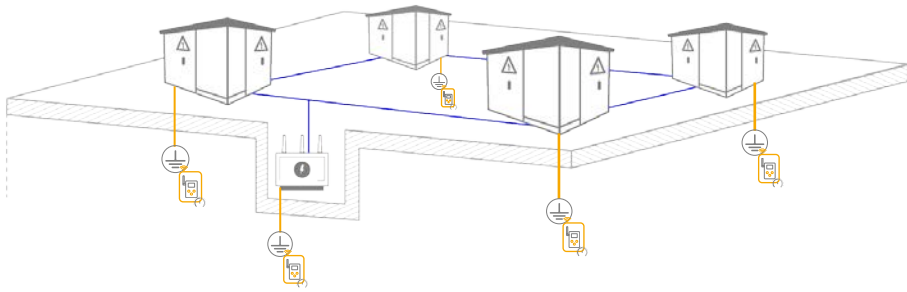

On-pole transformers

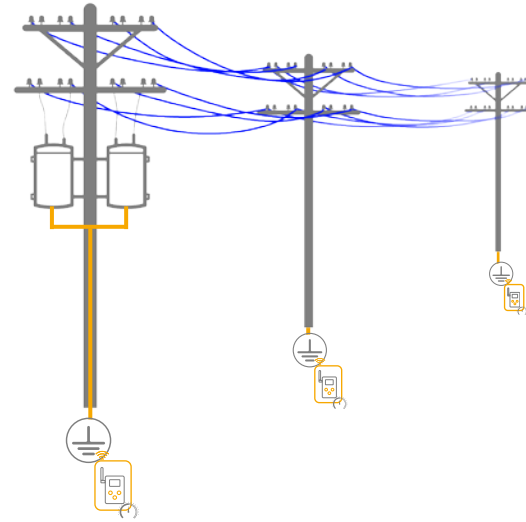

Overhead to Underground MV Towers

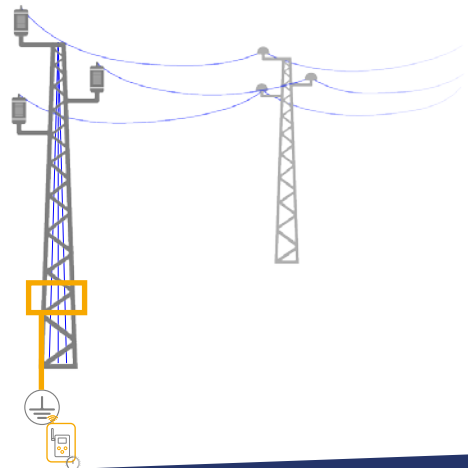

MV Power Tower

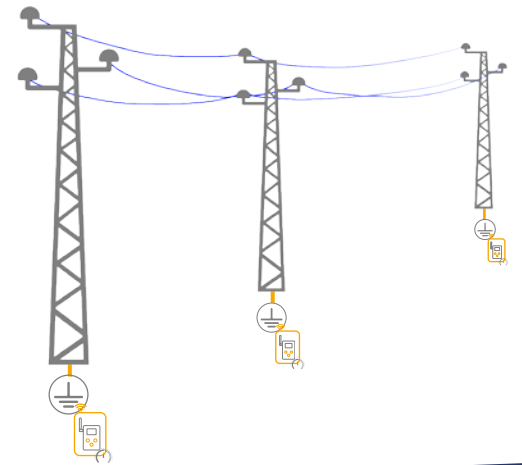

Remote supervision of the installed earthing system

- ▶ **Real-time determination of earthing system values**
 - Logistical and operational optimization of regulatory checks
- ▶ **Verification of asset-to-earthing connections**
 - Identification of both, asset non-connection as well as unrequired connection to the earthing system
- ▶ **Evaluation of earthing continuity**
 - Real-time alerts related to conductors breakage, vandalism or theft
- ▶ **Monitoring of earthing system corrosion level**
 - Signal decomposition analysis allows for the identification of very slow trends associated with the oxidation phenomenon

Earthing system as a huge and active sensor of electrical activity

- ▶ **Excessive leakage currents**
 - The detection of abnormal leakage current is normally linked to isolation degradation in the assets connected to the earthing system
- ▶ **Evaluation of current ground flow related with abnormal electrical activity in the facility**
 - Related to transformers, MV isolated cables, arresters, inverters, wind turbines, etc..
 - Presence of phase-neutral imbalances
 - Identification of the presence of harmonics' (50,100,150Hz...) in the earthing system to determine possible causes of failure
- ▶ **Evaluation of noise level present in the ground conductor**
 - Due to a defect in other elements connected to ground or by couplings on the monitored earthing systems.



SMART EARTHING MONITORING SYSTEM



FINANCIAL EFFICIENCY

Cost savings through logistical simplification of verification processes and early detection of asset failure situations



RISK MINIMISATION

Prevention of **critical situations** -step and touch voltages, fatal asset damages, etc..-



OPERATIONAL EFFICIENCY

Data-driven predictive maintenance that optimizes asset lifetime. **Real-time alerts for corrective maintenance.** Theft and vandalism detection.



SMART EARTHING MONITORING SYSTEM

Loop impedance measurement method

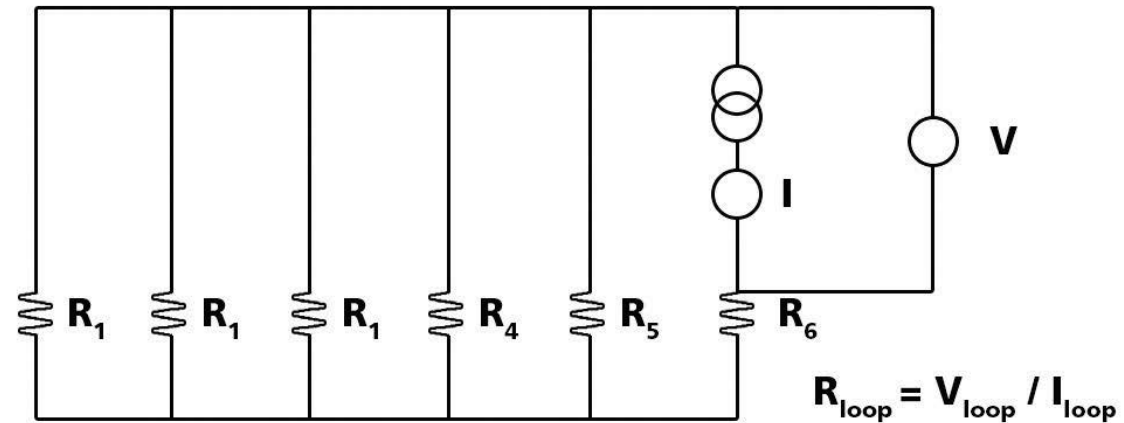
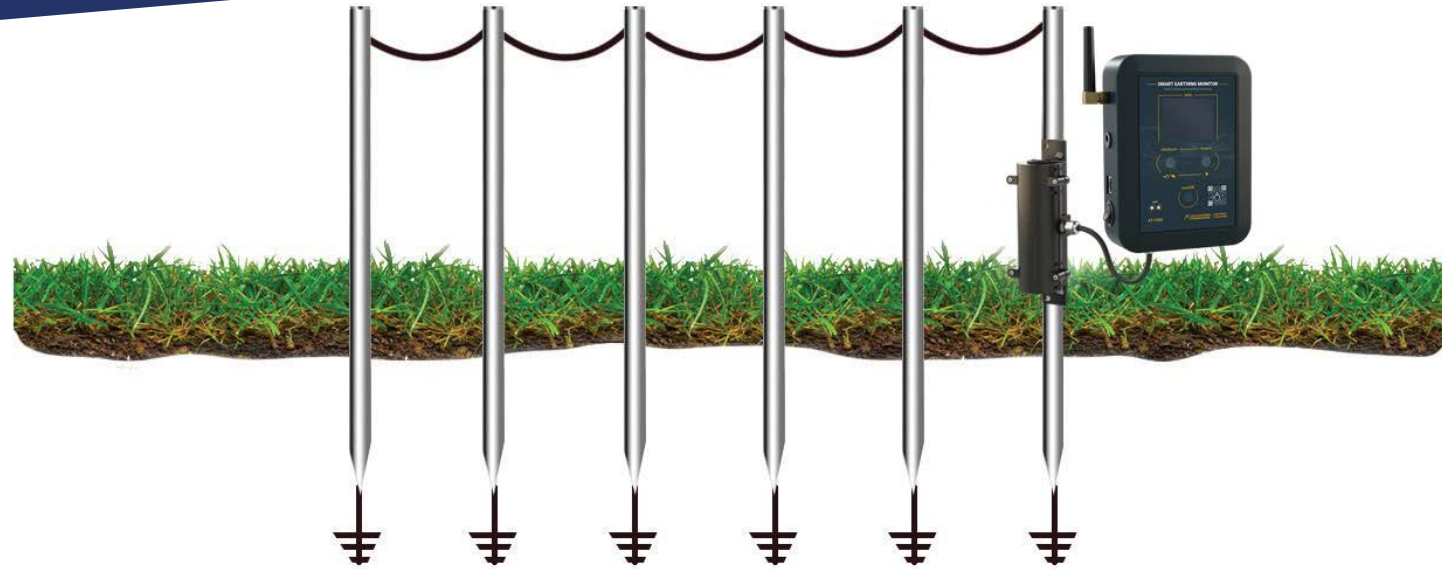

4 SYSTEM WORKING SQUEME

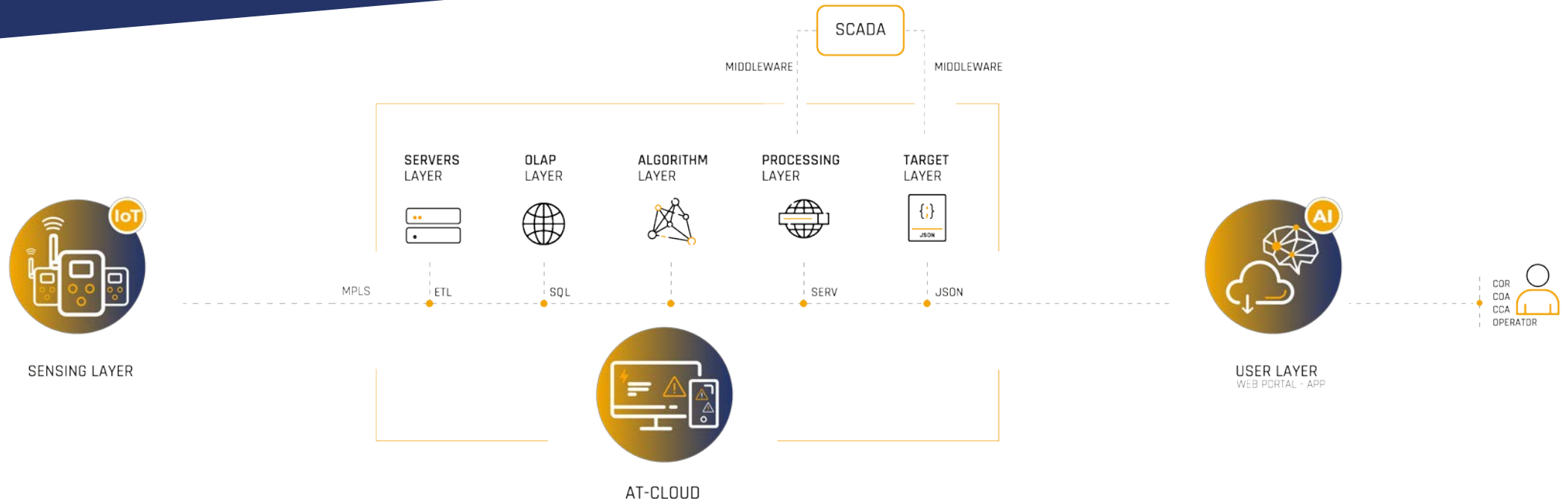

Sensing layer containing the distributed **smart sensors** on the assets to be monitored.

Interpretation of data through **AI algorithms** and server interaction transform **raw data into relevant information** for complete characterization of the monitored system.

User info can be delivered by **different configurable channels** and **access** to information segmented by user profile.

5 SYSTEM CONFIGURATION



► Power supply

- Mains power supply
- Direct from 48V batteries
- Autonomous supply via solar panel

► Battery

- 5Ah as power backup
- 10Ah for solar power applications

► Visualisation

- Optional 2.4" TFT screen for local operation

► Communication

- 2G/3G network
- IoT bands 4G (LTE-M, NB-IoT)
- LAN port Communication

► Enclosure

- Indoor use, wall or DIN rail mounting
- IP 65 outdoors weatherproof enclosure



6 FUNCTIONAL OPTIONS



▶ Real-time continuity

Generation of real-time alerts when a lack of continuity is detected.

▶ Autocalibration

Unattended calibration of equipment for regulatory verifications.

▶ Expansion port

Allows communication with other devices at site

▶ Potential-free outputs

Allows configurable local actuation

▶ Leakage current detection

Detection & evaluation of leakage current from equipment connected to the earthing system, e.g. autovalves, transformers, etc.

▶ Comm ports

Analog and digital ports to serve as a comm hub of external sensors

▶ Node evaluation

Status evaluation of interconnection between different earthing systems

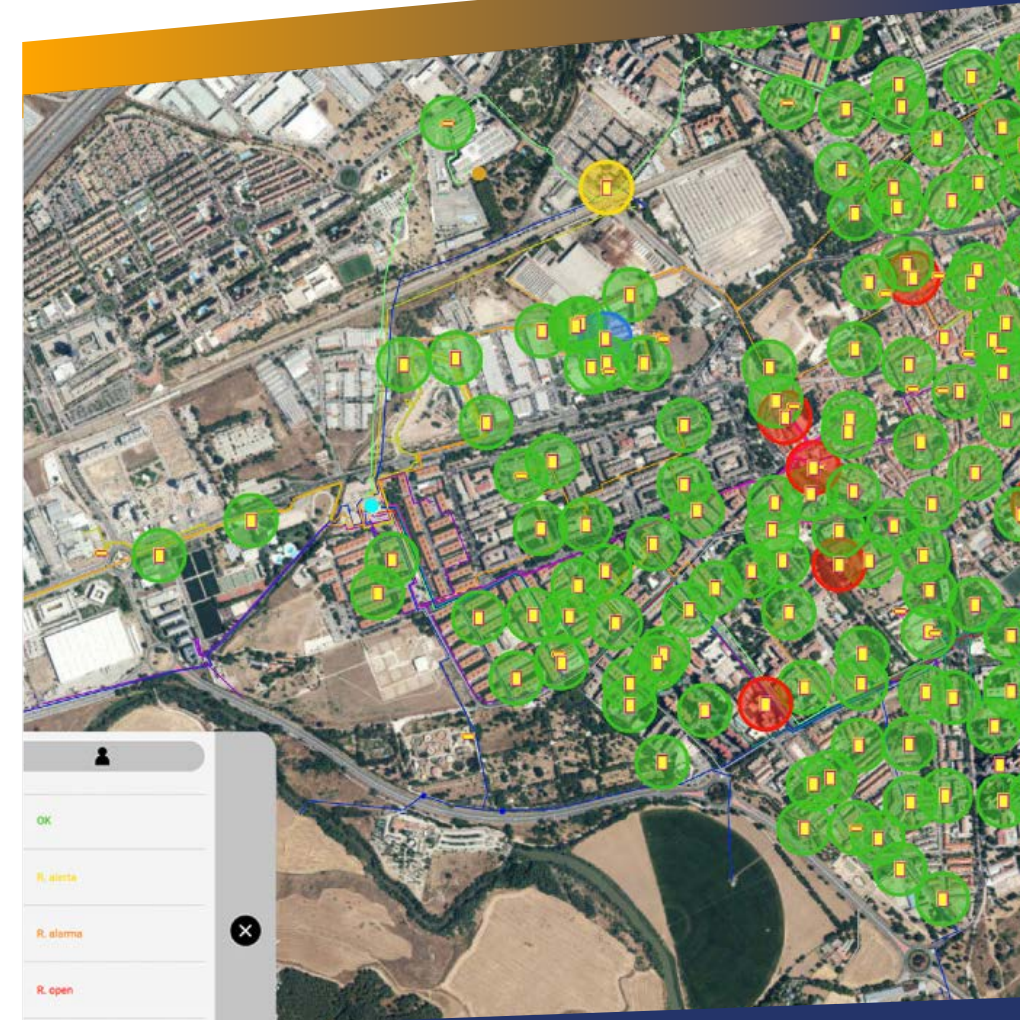

7 PLATFORM OPTIONS



▶ CCA platform

Alerts associated with earthing resistance, continuity measurements and leakage current

▶ COA platform

Alerts related to the equipment status.

▶ APP management for equipment activation/deactivation:

Mobile APP for management of activation/deactivation of installed equipment.

▶ SCADA

Integration of data processed in client's system.



▶ Application Maintenance Services

- Remote updating of the application
- 24x7 Technical Service
- Data backup

▶ Equipment Maintenance Services

- Remote equipment updates
- Remote equipment diagnostics
- 24x7 Technical Service
- Local data recovery
- Autocalibration

AT-CONNECT

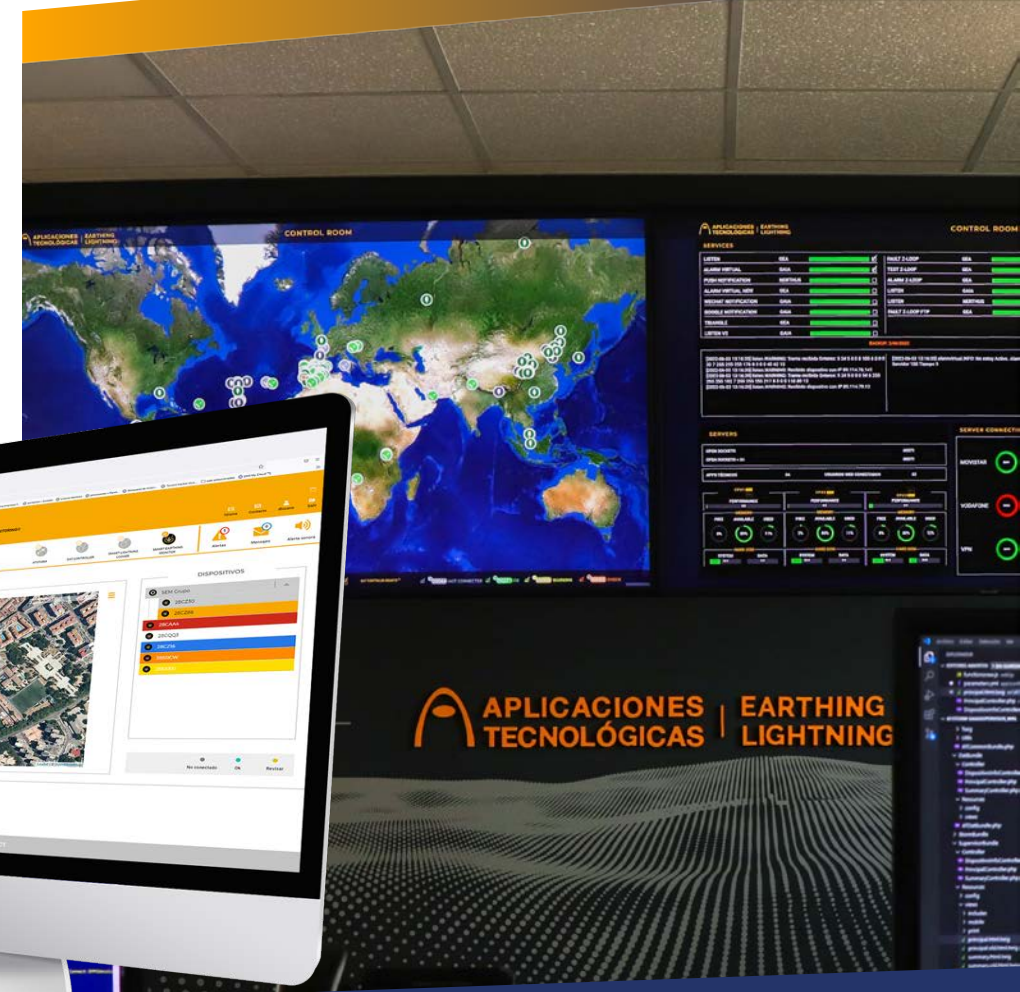
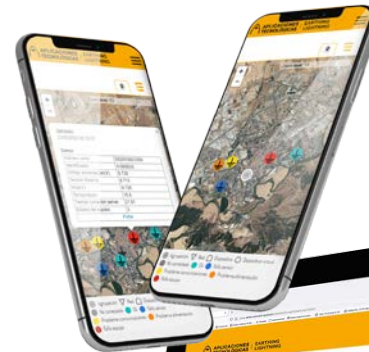

APLICACIONES TECNOLÓGICAS | EARTHING LIGHTNING



Other recommended services and products

Services

- ▶ Advanced geoelectrical studies.
- ▶ Earthing systems 4.0 projects.
- ▶ Smart storm detection projects.
- ▶ Lightning and overvoltage protection projects.

Products

- ▶ **ATSTORM®**
Smart early warning system for thunderstorm risk.
- ▶ **DAT CONTROLLER® REMOTE**
Smart air terminals with IoT technology.
- ▶ **OVERVOLTAGES**
Transient and permanent.



APLICACIONES TECNOLÓGICAS S.A.

Parque Tecnológico de Valencia

 C/Nicolás Copérnico, 4 - 46980 Paterna (Valencia), ESPAÑA.

Safe-x Eğitim ve Danışmanlık Türkiye Distribütörü



Kozyatağı mah. Sarıkanarya sok. By Ofis Plaza Kat 7, 34736

Kadıköy/İSTANBUL +90 216 906 11 01 +90 532 720 63 86

info@safeisg.com www.safeisg.com